

INNCFITTM

FURNITURE ADD-ONS

for

WORK SPACES

MUMBAI | PUNE | BENGALURU | DELHI NCR



SINCE 1981

The first company in India to innovate & introduce:

- Pop up Boxes with Indian electricals
- Monitor Arms
- CPU Holders

QUALITY

- A large number of leading architects and contractors rely on our trouble-free products for their projects.

- Most of our products are proudly **Made In India**



CUSTOMER OBSESSED

- We provide highest level of customer service
- We customize as per our customer's needs
- It is always our relentless quest to constantly innovate and provide productivity enhancing workspace additions.



THE LEADING PROVIDER OF POWER MODULES MANUFACTURED IN INDIA



PDX Console

Clamped to table top edge



PDX Surface

Mounted on the surface of the table



PDX PDU

Mounted under the table on Raceway



PDX PDU OT

Mounted over the table



PDX PDU UT

Mounted under the table

IEC Certified: 60884-2-7

AVAILABLE IN VARIOUS CONFIGURATION OPTIONS

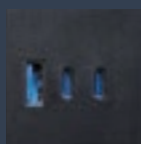

USB A+C+C
GAN charger 65W
(Laptop Charger)

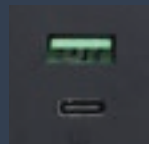

USB A+C
20W PD+QC3.0

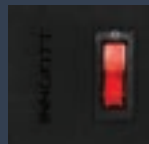

Switch



Indian Power
Socket

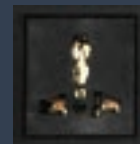

Universal Power
Socket



Data Cat6

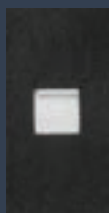

Telephone



HDMI



USB
(Data transfer)



GST Connector



GST Multiway Splitter
(1 x 3 & 1 x 5)



PDX RANGE



- Made in India
- All configurations available
- Import substitute
- Faster lead periods
- Available with Indian sockets
- Customisable for cluster workstation



WIRELESS CHARGER

Concealed Wireless Qi Charger

Product Code:
IS QF 10



- Fast Wireless Charging up to 15W
- Charging Distance is 10mm
- No Stress of Spills
- Attached under the table—Truly Invisible!
- Supports all Qi Wireless Charging devices including iPhone, Samsung Galaxy series, Nothing Phone etc.

Concealed Wireless Qi Charger

Product Code:
IS QF 30

- Wireless Charging up to 10W
- Charging Distance is 30mm
- No Stress of Spills
- Attached under the table—Truly Invisible!
- Supports all Qi Wireless Charging devices including iPhone, Samsung Galaxy series, Nothing Phone etc.



Wireless Qi Charger - On Surface

Product Code:
IS QF OS 1

- Fast Wireless Charging up to 15W
- Cut Out diameter: 74Ø
- Flush with Table Top
- Economical option for large deployments
- Supports all Qi Wireless Charging devices including iPhone, Samsung Galaxy series, Nothing Phone etc.



COMPACT

- Perfect for Individual Workstations and Meeting Rooms
- Space Saving



Product Code: IS CMP PSACD

Power, Switch, USB A+C Charger
20W PD+QC3.0, Data



Product Code: IS CMP PSAC

Power, Switch, USB A+C Charger
20W PD+QC3.0



Product Code: IS CMP PS

Power, Switch



Product Code: IS CMP PSACD

Power, Switch, USB A+C Charger
20W PD+QC3.0, Data



Product Code: IS CMP PSH

Power, Switch, HDMI



Product Code: IS CMP PSD

Power, Switch, Data



Out to Out Size: \varnothing 100
Cut Out Size: \varnothing 92

Switch Socket
CE Marked

ULTRA COMPACT

Product Code: IS UC PS

Power, Switch



- Colour: Black
- Cut Out size: 76 x 62mm

Product Code: IS UC PAC

Power, USB A + C Charger
20W PD + QC3.0



Switch Socket
CE Marked

MIKRO USB CHARGER



Product Code: IS MUC 53

USB Charger A+C

- With 20W PD+QC3.0
- Colour: Black
- Cut Out size: Ø 53mm

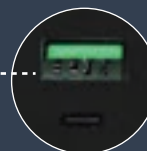

20W PD+QC3.0
USB A+C



VERTEBRAE



Product Code:
IS VBT 23L/CHB

- For HAT Back to Back Connector



Product Code:
IS VBT 17L/BC

- Vertebrae for 750mm Height Fixed Table



VERTEBRAE FOR HEIGHT ADJUSTABLE TABLE



Product Code:
IS VBT 29L/BC

- Vertical Cable Manager for Height Adjustable Tables

Colours: Grey, White & Black

Material: Plastic

Product Code:
IS VBT 26L/HZ

- Horizontal Cable Management with Anti-sag Clip



Product Code:
IS SGT 01

- Spring Tube Vertical Cable Manager (740mm)

Colour: White

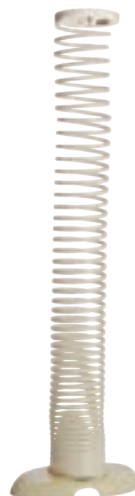

THE PREFERRED CHOICE FOR MONITOR ARMS IN INDIA

DYNAMIC MONITOR ARM



To know more,
scan the QR

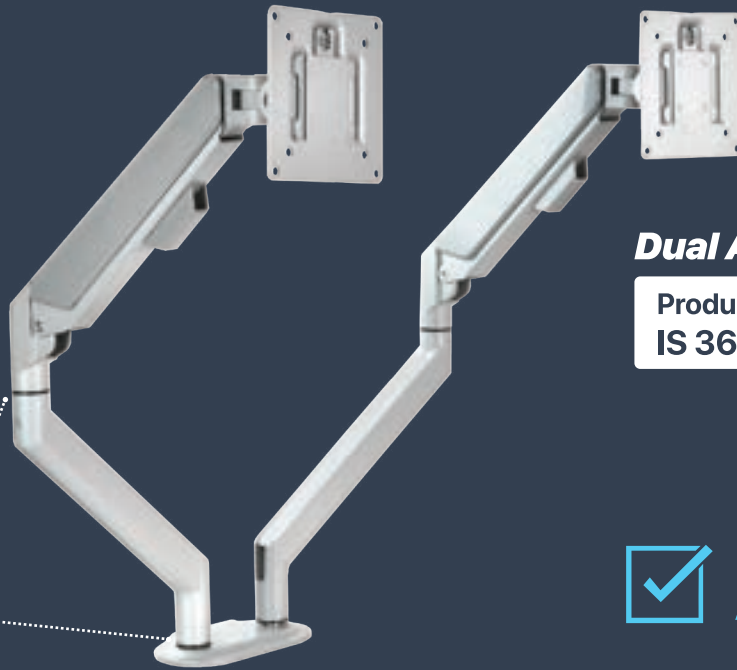

Dual Arm

Product Code:
IS 360 EM 2.1

90°
Locking



**BIFMA TESTED
ANSI/BIFMA X5.5-2021**

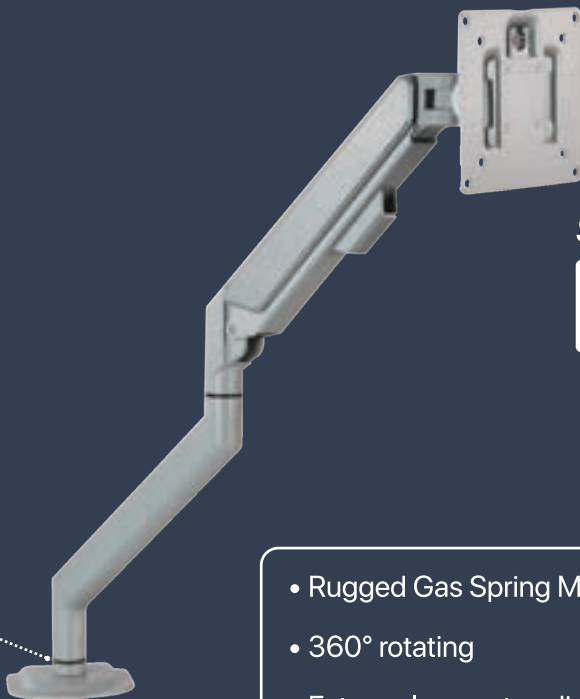

Single Arm

Product Code:
IS 360 EM 1.1

90°
Locking



- Rugged Gas Spring Mechanism
- 360° rotating
- Extremely easy to adjust to desired position
- Quick release VESA mount
- Height and Distance adjustable
- Size of monitor up to 32"
- Concealed Cable Management
- Both Clamp and Flange mounting solutions included
- Supports Monitors up to 12 kg



MONITOR STANDS - ALUMINIUM SERIES



Dual Monitor

**Product Code:
IS FX 2 F**



Single Monitor

**Product Code:
IS FX F**

- Ergonomic: Reduces risk of Head, Neck and Eye strain
- Precision engineered to prevent cantilever load effect
- Allows user to adjust the position of one or multiple screens with minimum effort and maximum precision
- Space Saving
- Swivel, Tilt and 360° rotation allows you exceptional mobility
- Concealed Cable Management
- Colour: Metallic Silver Grey





Partition Mount

Product Code:
IS FX PM 02

Dual Arm with Freestanding Base

Product Code:
IS FX 2 FS



Dual Monitor Vertical

(Short link)

Product Code:
IS FX 2 SL DV F



Dual Monitor

(Vertical mount)

Product Code:
IS FX 2 DV F

- Height Adjustable
- Increased viewing comfort.
Reduced Eye, Back and Neck strain.
- Portrait and Landscape viewing options
- Supports monitors up to 8 kg

- Compatible with all VESA Standard Monitors
(75mm x 75mm and 100mm x 100mm)
- Suitable for fixing on Partition as well as on Wall
- Colour: Metallic Silver Grey

Trio Monitor

Product Code:
IS FX 3T F



Quad Monitor

Product Code:
IS FX 4 F

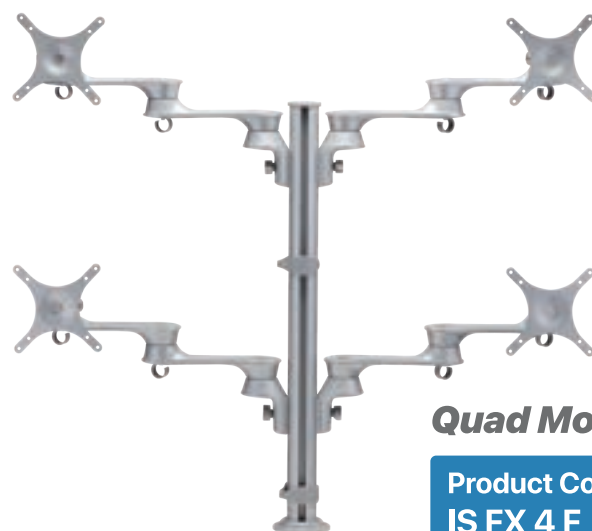

Single Monitor-Short Link

Product Code:
IS FX SL F

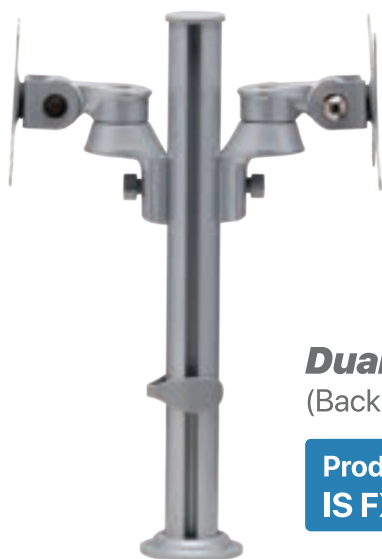

Dual Monitor

(Back to Back)

Product Code:
IS FX 2 BB F

Colour: Metallic Silver Grey



Flange Mount



Clamp Mount



Free Standing
(For selected models)





MONITOR STANDS - STEEL SERIES



Single Monitor
(With Flange)

Product Code:
ISEV F

Clamp Type :
ISEV C

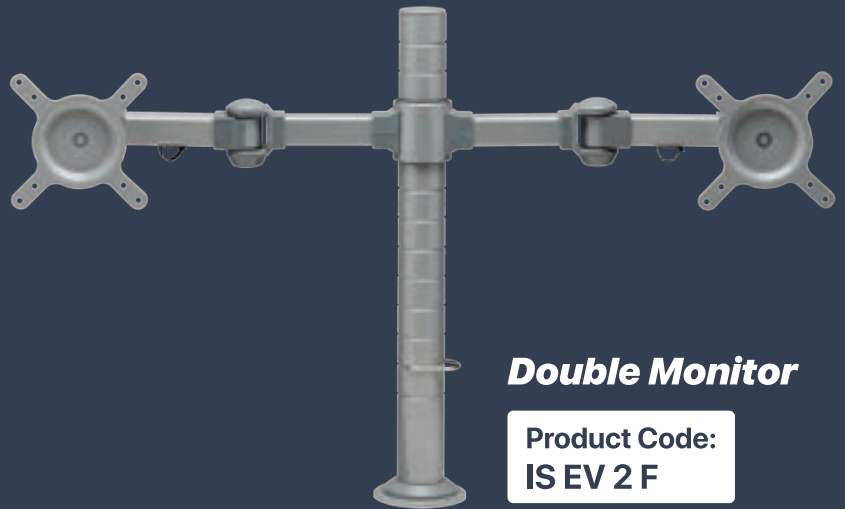

Double Monitor

Product Code:
ISEV 2 F



Single Monitor
(Short Link)

Product Code:
ISEV 1 SL F



Dual Monitor
(Short Link)

Product Code:
ISEV 2 SL F

- Adjust monitor as per individual user comfort - Height, Distance & Angle
- Space Saving. Since footprint of stand is much less than footprint of monitor base, architects can shorten table depth by 6"
- Portrait and Landscape viewing options

- Compatible with all VESA Standard Monitors (75mm x 75mm and 100mm x 100mm)
- With Cable Management for neat wiring
- Each arm supports monitors up to 10 kg
- Colour: Metallic Silver Grey





Three Monitor Arm
(Horizontal)

Product Code:
IS EV 3 F (H)

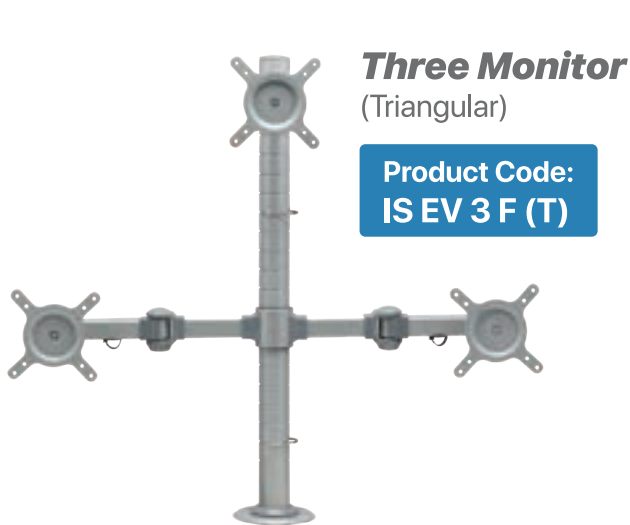

Three Monitor
(Triangular)

Product Code:
IS EV 3 F (T)

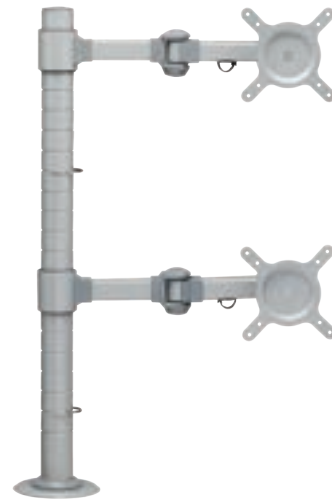

Double Monitor
(Vertical Mount)

Product Code:
IS EV 2 DV F

Partition Mount



Single Link
± 45° Tilt, ± 30° Swivel

Product Code:
IS EV WMS

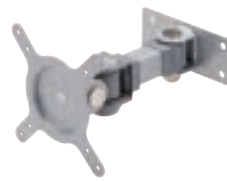

Double Link
± 45° Tilt, ± 60° Swivel

Product Code:
IS EV WMD

- Keeping monitors off the table will help to save space. One can plan 6" shorter table, hence cost of table is reduced.
- Mounting options- Flange | Clamp | Free standing (For selected models)
- Supports monitors up to 10 kg
- Portrait and Landscape viewing option
- Compatible with all VESA Standard Monitors (75mm x 75mm and 100mm x 100mm)
- Colour: Metallic Silver Grey



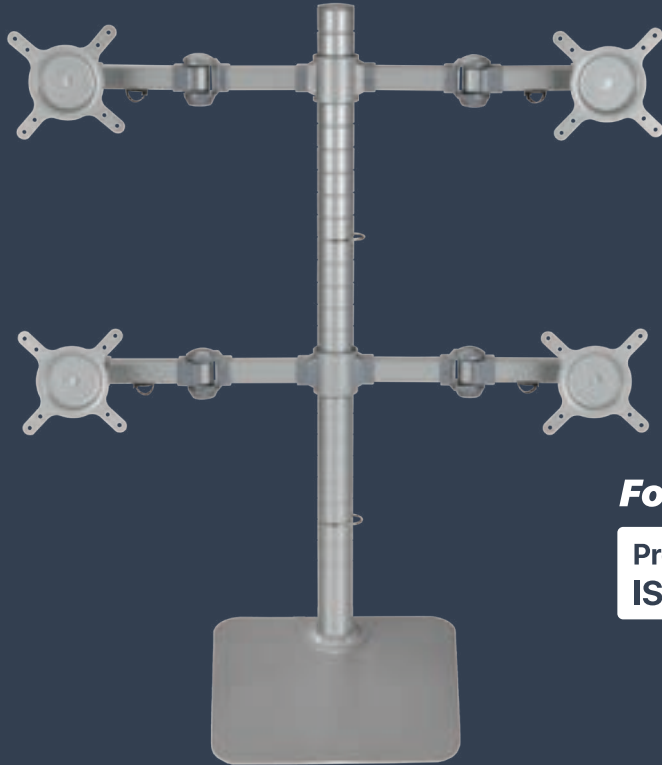

Four Arm with Freestanding Base

**Product Code:
IS EV 4 FS**

Colour: Metallic Silver Grey

Four Monitor

**Product Code:
ISEV 4 F**

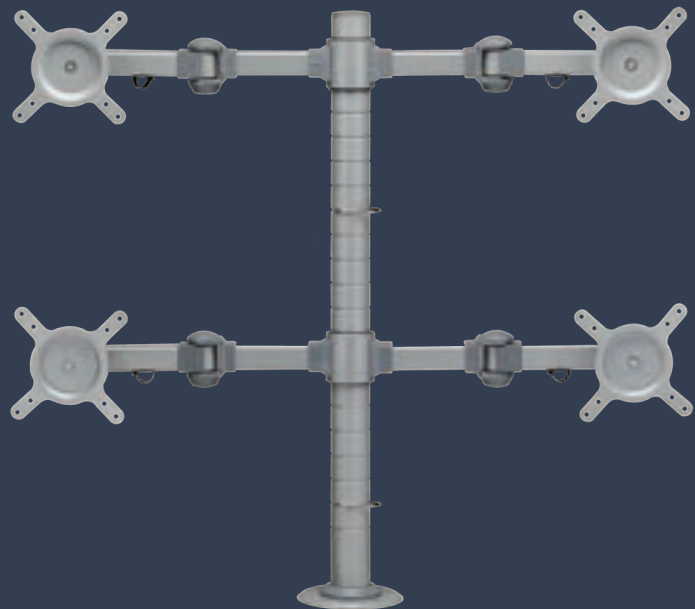

Flange Mount



Clamp Mount

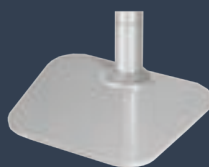

Free Standing
(For selected models)



FOLDING TABLE

- Knob operated Folding Mechanism
- With Bookshelf
- All Four Lockable Castors
- Stackable
- Colour: White
- With Modesty Panel Brackets



**Product Code:
IS FT 04**

Suitable for table tops:
600x1200
600x1500
600x1800



**Product Code:
IS DC 2601**



To know more,
scan the QR

Desk Converter DC 01

- Minimum Height: 45mm
- Maximum Height: 405mm
- Table top size: 670mm X 470mm
- Height Adjustment: Manual
- Weight Capacity: 8 kg

FEATURES:

- Spring Mechanism
- Height Lockable at 6 levels
- Lever for easy height adjustment
- Slim and Space saving
- Anti-skid pads for scratch-free surfaces



EasyFold

INNOFITT™

FOLDING TABLE

FOLD IT! ROLL IT! STACK IT!



Product Code:
IS FT 02

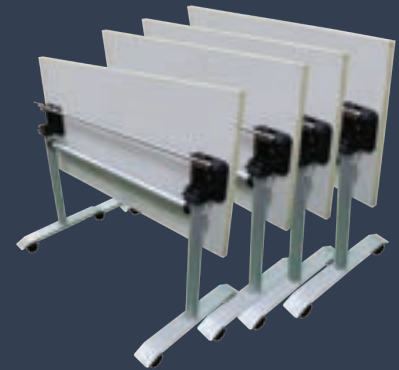

- German Mechanism
- Stackable
- All Four Lockable Castors
- Colour: Metallic Silver Grey
- Modesty Panel Brackets (optional)

Available Sizes:

- 600 x 1200mm
- 750 x 1200mm
- 600 x 1500mm
- 750 x 1500mm



InnoFold



Product Code:
IS FT 03



- Premium Design
- Stackable
- All Four Lockable Castors
- Colour: White
- Modesty Panel Brackets (optional)

Suitable for table tops:

- Length: 1200 ~ 1800mm
- Width: 600 ~ 800mm



CONFERENCE ROOM SOLUTION **HEIGHT ADJUSTABLE CONFERENCE TABLE**



3 Motor, 3 Stage

Product Code:
IS CONF 3M 3S

Control Panel with LED Display
4 Memory presets
With Anti-collision Feature
Hi-quality rugged steel



- Frame length adjustability: 1800 - 2900mm
- Minimum table top size: 900 x 2000mm
- Maximum table top size: 1200x 3000mm (up to 10 seaters)
- Weight Capacity: 150 kg



THE HEIGHT OF YOUR CONVENIENCE AT YOUR FINGERTIPS!

EC1 – 2 Motor, 2 Stage

**Product Code:
IS HAT EC1 - 2M 2S**

- Value Engineered Model
- With Anti-collision Feature
- Minimum Height: 740mm
- Maximum Height: 1220mm
- 3 Memory Presets
- Digital Display of Height
- Timer for stand-up reminders (Customisable)
- Weight Capacity: 80 kg



2 Motor, 2 Stage

**Product Code:
IS HAT 2M 2S**

- Premium Model
- With Anti-collision Feature
- Minimum Height: 720mm
- Maximum Height: 1220mm
- Above heights are including table top
- Control Panel with LED Display & 4 Memory Presets
- Weight Capacity: 120 kg



- Easy to operate, smooth to lift
- Soft start/stop technology, no jerking and no jolting

- High quality rugged steel
- Colour: White & Black



HEIGHT ADJUSTABLE TABLE

Single Motor, 2 Stage

**Product Code:
IS HAT 1M 2S**

- Minimum Height: 710mm
- Maximum Height: 1190mm
- 3 Memory Presets
- Digital Display of Height
- Weight Capacity: 80 kg



Manual, 2 Stage

**Product Code:
IS MT 2S**

- Minimum Height: 700mm
- Maximum Height: 1150mm
- Above heights are including table top
- Weight Capacity: 80 kg





SINGLE COLUMN HEIGHT ADJUSTABLE TABLE



Single Column Hydraulic

Product Code:
IS HYL SC HAT

- Table top size: 800mm x 560mm
- Minimum Height: 755mm
- Maximum Height: 1126mm
- Multiple Height Levels
- Weight Capacity: 8 kg
- Provision for Tab & Glass holder
- Available with Levers and Casters

Single Column Hydraulic Stackable Folding Table

Product Code:
IS HYL SC HAT FT

- Table top size: 600mm x 520mm
- Minimum Height: 820mm
- Maximum Height: 1190mm
- Multiple Height Levels
- Table top can be tilted in multiple angles (10°, 20°, 30°, 90°)
- Stackable
- Weight Capacity: 8 kg
- Edge stopper
- Available with Levers and Casters



Foldable Table Top



Adjustable Tilt



Edge Stopper



Multiple Height Levels



ACCESS FLAP

- Available in: 300mm, 450mm & 600mm
- Cut Out: 132mm x 316/466/616mm
- Out to Out: 148mm x 332/482/632mm
- Option: Gasket & Brush

Colours: Metallic Silver Grey & Frosty White



- Easy to access electricals under the table
- Import Substitute
- With optional soft close feature
- Available in other sizes on request

XIOFLIP

- Available in: 300mm & 450mm
- Cut Out: 140mm x 319/468mm
- Out to Out: 154mm x 332/482mm
- Option: With or without brush

Colours: Metallic Silver Grey & Frosty White



DeskPort

INNOFIT™

FTB 154 Manual

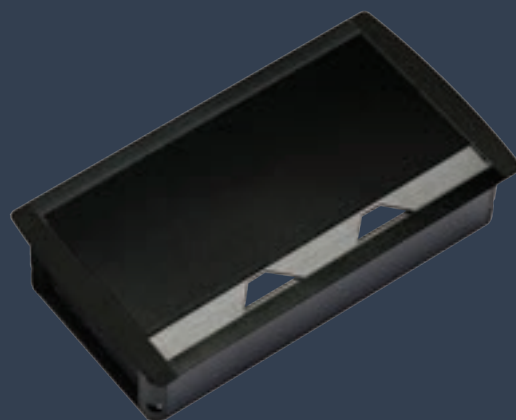
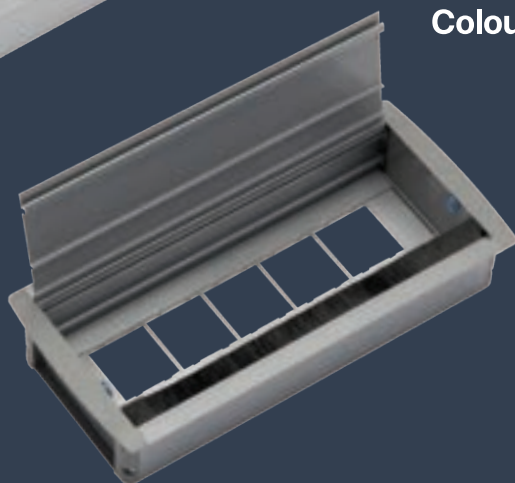

- Available in 6, 8, 10 & 12 modules
- Elegant Design
- Option of Gasket or Brush
- Cut Out: 132mm x 216/266/316/366mm
- Out to Out: 154mm x 232/282/332/382mm

Colour: Metallic Silver Grey
Black
White



- Eliminates carpentry work
- Smart looks
- Easy to install

The perfect solution for connectivity on:

- Conference tables
- Meeting room tables
- Desking tables
- Linear workstations
- Lab furniture
- Hotel rooms
- Educational furniture
- TV studios

FTB 164 Hydraulic



- Hydraulic Mechanism
- Smooth Operation
- Cut Out: 110mm x 225mm
- Out to Out: 118 x 265mm

Colour: Silver

Configuration: 2 Power, 2 Data Cat 6, VGA,
HDMI, Audio, USB



DeskPort 180 Motorized

FTB - 180

Product Code:

IS FTB 180/23 - 12M

- Pre-wired
- Rotate by pressing the button
- Configuration: 1 Switch, 2 Universal Sockets, 1 USB Charger A+C 18W, 2 Data Cat 6, 1 HDMI
- Colour: Sparkle Silver
- Out to Out: 110mm x 404mm
- Cut Out size: 103mm x 373mm



DeskPort 170 Revolve

FTB 170 Revolve 8 Module

Product Code:

IS FTB 170/23 - 8M

- Pre-wired
- Turn 180° to open & close panel
- Configuration: 1 Switch, 2 Universal Sockets, 1 USB Charger A+C 18W, 2 Data Cat 6
- Colour: Sparkle Silver
- Out to Out: 110mm x 300mm
- Cut Out size: 103mm x 268mm



DeskPort 170 Revolve

FTB 170 Revolve 9 Module

Product Code:

IS FTB 170/23H - 9M

- Pre-wired
- Turn 180° to open & close panel
- Configuration: 1 Switch, 2 Universal Sockets, 1 USB Charger A+C 18W, 2 Data Cat 6, 1 HDMI
- Colour: Sparkle Silver
- Out to Out: 110mm x 325mm
- Cut Out size: 103mm x 293mm



FTB 165 FlipUp

Product Code:
IS FTB 165 FP

- Pre-wired
- Superior enclosure for Power sockets & Ports
- Configuration: 1 USB Charger A+C 18W, 2 Universal Sockets, 1 Data Cat 6, 1 HDMI
- Colour: SS Brush / Panel: Black
- Out to Out: 102mm x 284mm
- Cut Out size: 71mm x 270mm



FTB 165 Slider

Product Code:
IS FTB 165 SL

- Pre-wired
- Smooth Sliding Panel
- Configuration: 2 Universal Sockets, 1 USB A+C Charger 18W, 1 Data Cat 6, 1 HDMI
- Colour: SS brush / Panel: Black
- Out to Out: 100mm x 280mm
- Cut Out size: 73mm x 272mm



KBD SOLUTIONS (PLASTIC)



Keyboard Drawer (Denzo)
with softPAD

Keyboard Drawer (Denzo)

- Large Pencil Compartment
- Tray size: 535mm (W) x 200mm (D)

Product Code:
IS KD Denzo (Basic)
IS KD Denzo MT

(With Mouse Tray)
Colour: Black

- With cushioned softPAD
- Tray size: 535mm (W) x 200mm (D)

Product Code:
IS KD Denzo SP
IS KD Denzo SP MT

(With Mouse Tray)

Keyboard Drawer (Plastic) - KD 575

- Integral Pencil Holder
- Tray size: 575mm (W) x 300mm (D)

Product Code:
IS KD 575 P
IS KD 575 P MT

(With Mouse Tray)
Colour: Black



KBD SOLUTIONS (METAL)



Keyboard Drawer (Metal) 25"

- Accommodates Mouse alongside Keyboard
- Tray size: 645mm (W) x 225mm (D)

Product Code:
IS KD 645 M
IS KD 645 M SP

(With softPAD)
Colour: Black



Keyboard Drawer (Metal) 19" SST

- With High Performance Imported Slides
- Tray size: 510mm (W) x 200mm (D)
- Economical

Product Code:
IS KD 510 M SST
IS KD 510 MT SST

(With Mouse Tray)
Colour: Black



Keyboard Drawer (Metal) 19"

- With High Performance Imported Slides
- Tray size: 510mm (W) x 200mm (D)

Product Code:
IS KD 510 M
IS KD 510 M MT

(With Mouse Tray)
Colour: Black

- With cushioned softPAD
- Tray size: 535mm (W) x 200mm (D)

Product Code:
IS KD 510 M SP
IS KD 510 M SP MT

(With Mouse Tray)
Colour: Black





CPU Holder (Fixed)

Product Code:
IS CPU HL
IS CPU HL SLM

- Width Adjustable (150mm to 225mm)
- Height Adjustable (300mm to 475mm)

Colour: Black

Also available in **Slim Version**
Width Adjustable (80-120)



**Load
Bearing
Capacity
8-10 kg**

CPU Holder (Swivel & Pull Out)

Product Code:
IS CPU HL SW PL
IS CPU HL SW

- Swivel & pull out for easy access to the rear of the CPU
- 360° Swivelling
- Height Adjustable (300mm to 425mm)
- Width Adjustable (150mm to 225mm)

Colour: Black

Also available in **Swivel** only



CPU Trolley SST

Product Code:
IS CPU SST

- With Lockable Castors for easy mobility
- Width Adjustable
- Economical

Colour: Black



Thin Client Holder

Product Code:
IS TCH 01

- Saves table space
- 360° Swivelling
- Easy access to rear panel
- Height Adjustable (30mm to 50mm)

Colour: Black



GOOD POSTURE STARTS FROM YOUR FEET



ErgoREST- Footrest

Product Code:
IS ER 445

- Ergonomic Footrest
- Promotes Stress-free Posture
- Angle Adjustable
- Slip resistant surface
- Reduces pressure on the back of the thigh
- Platform Size: 445mm (W) x 295mm (D)

Colour: Black

COMPLETE CONVENIENCE AT YOUR FINGERTIPS



Easyfit Drawer - Small

Product Code:
IS ED 3025 F

Inner Dimension
215mm (W) × 320mm (D) × 60mm (H)

Cost-effective alternative
to 3 drawer pedestal

Easyfit Drawer - Big

Product Code:
IS ED 4130 F

Inner Dimension
415mm (W) x 300mm (D) x 60mm (H)



- Ready to install
- Slides and Mounting Brackets included
- Can use Wooden Facia instead of Metal Facia



PARTITION HOLDER

- For all types of screens (Glass, Acrylic, MDF, etc)
- Width Adjustable
- Available in White & Metallic Silver Grey

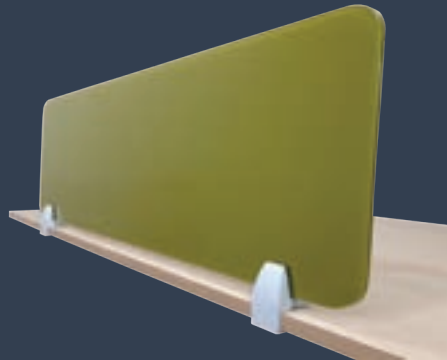

**Product Code:
IS PH CLMP 25**

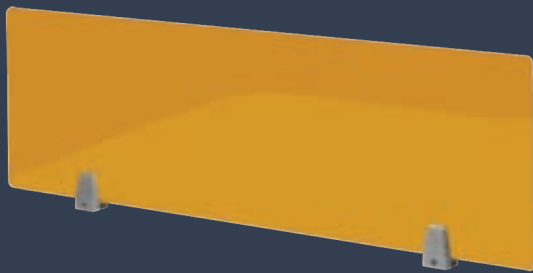

**Product Code:
IS PH 01**

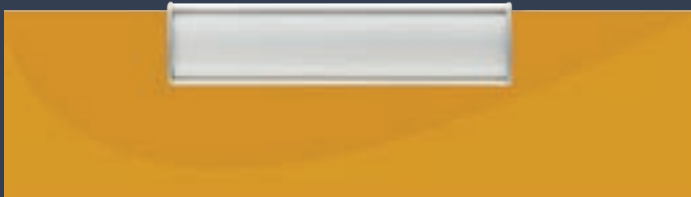

NAME PLATE

**Product Code:
IS NP 50210**

- Size: 210mm (L) x 50mm (H)
- Various mounting options available
 - Z Type
 - U Type
 - Plain
- Can also be customized



MONITOR ARM WITH LAPTOP HOLDER



Laptop Holder

Product Code:
IS EV LPTS2 F
IS EV LPTS2 C



- Desk mounted Laptop Stand
- Robust Ergonomic Design
- For Laptops up to 17 inches
- Swivel and Height Adjustable
- Saves table space
- Option of Clamp Mount or Flange Mount
- Colour: Metallic Silver Grey



PROJECT IMAGES PAN INDIA

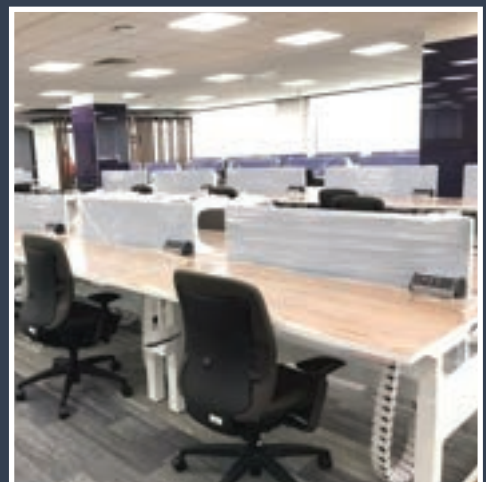
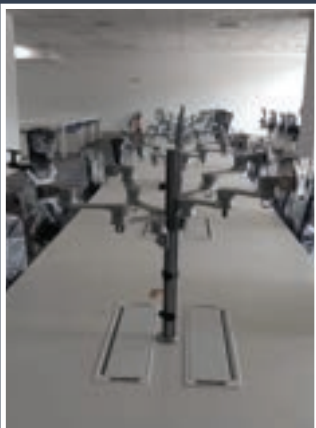
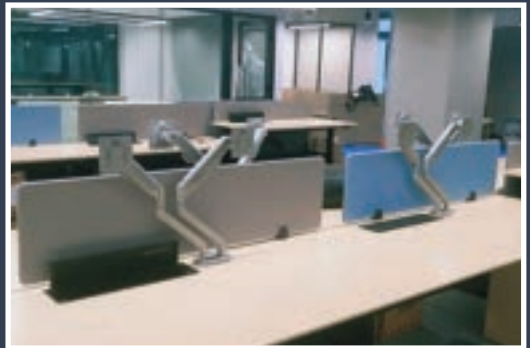

LIST OF INSTALLATIONS

CO-WORKING

- Smartworks
- Simpliwork
- Awfis
- UrbanWrk
- WeWork
- Indiqube
- Workafella
- ClayWorks
- Table Space
- Enzyme

CORPORATES

- Mercedes Benz
- Samsung
- NDTV
- Asian Paints
- Taj Group
- Cap Gemini

BFSI

- Citi
- ICICI Bank
- HDFC Bank
- Morgan Stanley
- BNP Paribas
- Standard Chartered
- Axis Bank
- State Bank of India
- JPMC
- Nomura

INSTITUTIONAL

- Mumbai Police Control Room
- Bangalore Air Traffic Control
- Indian Navy
- Bombay Stock Exchange
- Manipal School of Architects
- Mumbai Air Traffic Control
- IIM Ahmedabad
- IIT Madras

IT

- IBM
- Dell
- HP
- Google
- Microsoft
- TCS
- Wipro
- Infosys
- Directi
- Genpact

CORPORATE OFFICE & DISPLAY:

No. 506 Ascot Centre, Sahar Airport Rd, Opp. ITC Maratha, Andheri East, Mumbai, Maharashtra 400099.

PUNE FACTORY & DISPLAY:

Plot No 114, Ramtekdi Industrial Estate, Near Vertiv, Hadapsar, Pune 411 013.

 1800 120 2429  marketing@innofitt.com  www.innofitt.com

MUMBAI | PUNE | BENGALURU | DELHI NCR